

## 40V<sub>DS</sub>/±20V<sub>GS</sub> N-Channel MOSFET

### General Description

These N-Channel enhancement mode power field effect transistors are using SGT technology. This advanced technology has been especially tailored to minimize on-state resistance, provide superior switching performance, and withstand high energy pulse in the avalanche and commutation mode.

### Features

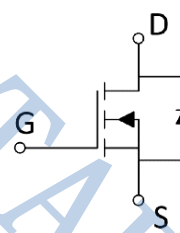
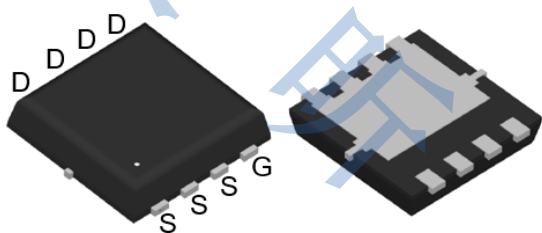
<b>BVDSS</b>	<b>40V</b>
<b>R<sub>DS(ON)</sub>(10V)</b>	<b>9.5mΩ (TYP)</b>
<b>R<sub>DS(ON)</sub>(4.5V)</b>	<b>13.3mΩ (TYP)</b>
<b>I<sub>D</sub></b>	<b>38A</b>

100% UIS TESTED!

100% ΔV<sub>ds</sub> TESTED!



PDFN3030



### Absolute maximum ratings (T<sub>A</sub>=25°C)

Symbol	Parameter	Value	Unit
V <sub>DS</sub>	Drain-Source Voltage	40	V
V <sub>GS</sub>	Gate-Source Voltage	±20	V
I <sub>D</sub>	Continuous Drain Current (T <sub>C</sub> =25°C)	38	A
	Continuous Drain Current (T <sub>C</sub> =100°C)	24	A
I <sub>DM</sub>	Pulsed Drain Current	95	A
I <sub>AS</sub>	Avalanche Current (L=0.1mH)	20	A
E <sub>AS</sub>	Single Pulsed Avalanche Energy	20	mJ
P <sub>D</sub>	Maximum Power Dissipation (T <sub>C</sub> =25°C)	28	W
	Maximum Power Dissipation (T <sub>C</sub> =100°C)	11.3	W
T <sub>J</sub> , T <sub>STG</sub>	Operating, Storage Temperature Range	-55~150	°C

### Thermal Characteristics

Symbol	Parameter	Typ.	Max.	Unit
R <sub>θJC</sub>	Thermal Resistance, Junction-to-Case	4.4	---	°C/W
R <sub>θJA</sub>	Thermal Resistance, Junction-to-Ambient	62	---	°C/W

**Electrical Characteristics** ( $T_J=25^{\circ}\text{C}$ , unless otherwise noted)

**Static State Characteristics**

Symbol	Parameter	Test Conditions	Min.	Typ.	Max.	Unit
$B_{VDSS}$	Drain-Source Breakdown Voltage	$V_{GS}=0V, I_D=250\mu A$	40	---	---	V
$I_{DSS}$	Zero Gate Voltage Drain Current	$V_{DS}=40V, V_{GS}=0V$	---	---	1	$\mu A$
$I_{GSS}$	Gate -Source Leakage Current	$V_{GS}=\pm 20V, V_{DS}=0V$	---	---	$\pm 100$	nA
$V_{GS(th)}$	Gate Threshold Voltage	$V_{DS}=V_{GS}, I_D=250\mu A$	1.1	1.5	1.9	V
$R_{DS(ON)}$	Drain-Source On-stage Resistance	$V_{GS}=10V, I_D=15A$	---	9.5	11.5	m $\Omega$
		$V_{GS}=4.5V, I_D=10A$	---	13.3	17.0	

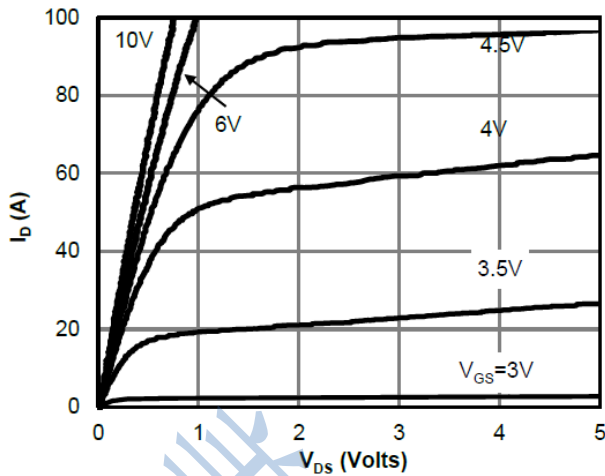
**Dynamic Characteristics**

Symbol	Parameter	Test Conditions	Min.	Typ.	Max.	Unit
$C_{iss}$	Input capacitance	$V_{DS}=20V$ $V_{GS}=0V$ $f=1MHz$	---	450	---	pF
$C_{oss}$	Output capacitance		---	85	---	
$C_{rss}$	Reverse transfer capacitance		---	10.5	---	
$R_g$	Gate Resistance	$f=1MHz$	---	2.8	---	$\Omega$
$Q_g$	Total Gate Charge	$V_{DS}=20V$ $V_{GS}=10V$ $I_D=10A$	---	6.2	---	nC
$Q_{gs}$	Gate Source Charge		---	1.5	---	
$Q_{gd}$	Gate Drain Charge		---	0.7	---	
$t_{d(on)}$	Turn-on delay Time	$V_{DS}=20V$ $V_{GS}=10V$ $R_G=3\Omega$ $I_D=10A$	---	8.4	---	ns
$t_r$	Rise time		---	2.8	---	
$t_{d(off)}$	Turn-off delay Time		---	17.5	---	
$t_f$	Fall time		---	3.1	---	
$V_{SD}$	Diode Forward Voltage	$V_{GS}=0V, I_{SD}=10A$	---	0.7	1.2	V
$t_{rr}$	Reverse Recovery Time	$I_D=10A$ $d_i/d_t=100A/\mu s$	---	10	---	ns
$Q_{rr}$	Reverse Recovery Charge		---	18.3	---	nC

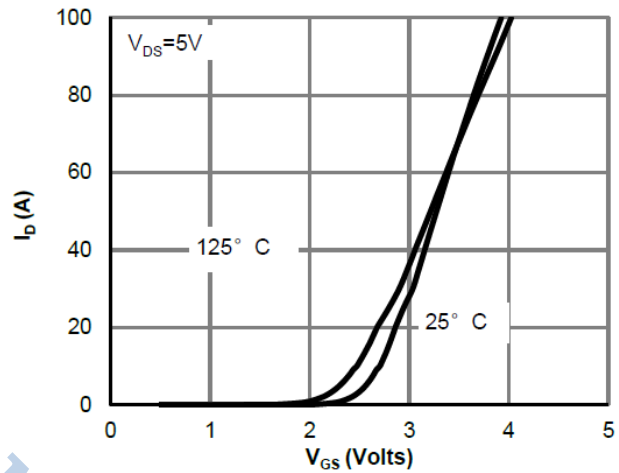
**Note:**

- 1.Repetitive Rating : Pulsed width limited by maximum junction temperature.
- 2.The data tested by pulsed , pulse width  $\leq 300\mu s$  , duty cycle  $\leq 2\%$ .
- 3.Essentially independent of operating temperature.

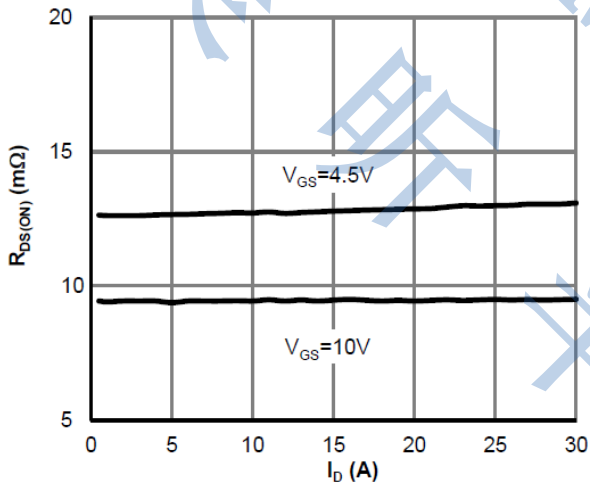
## Electrical Characteristics Diagrams



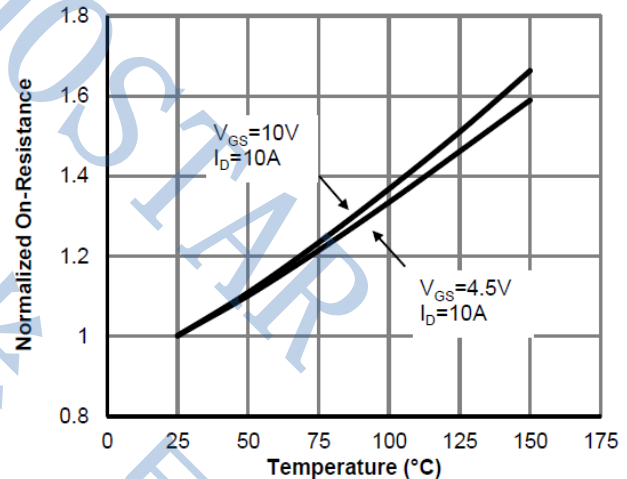
**Figure 1. On-Region Characteristics**



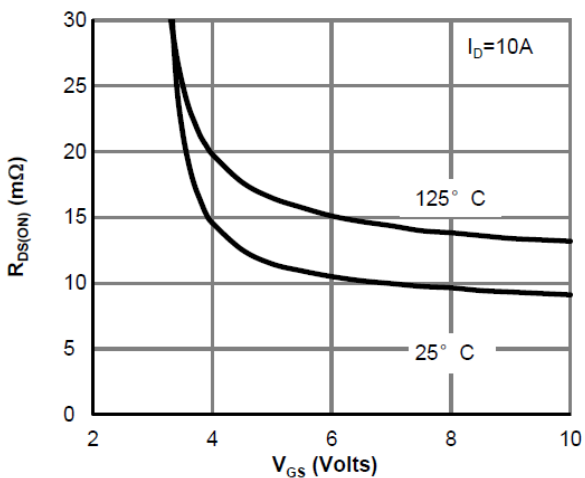
**Figure 2. Transfer Characteristics**



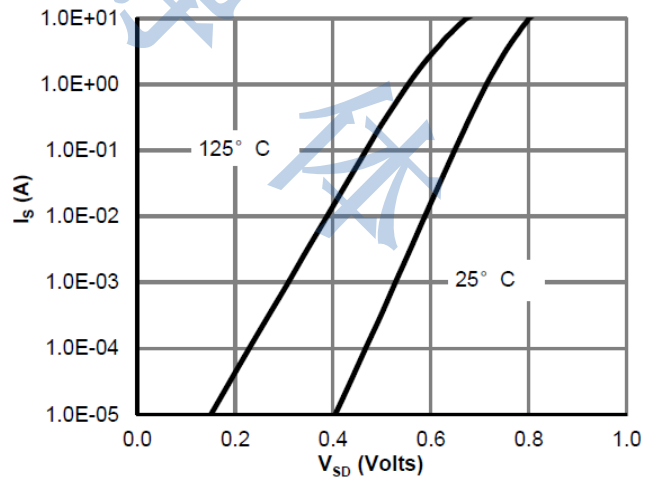
**Figure 3.  $R_{DS(on)}$  vs.  $I_D$  and Gate Voltage**



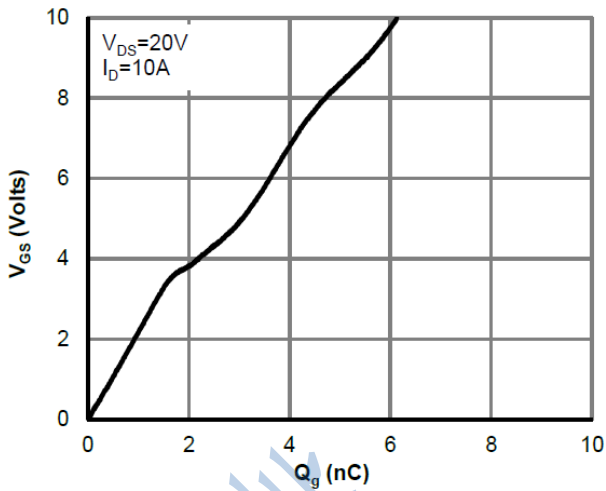
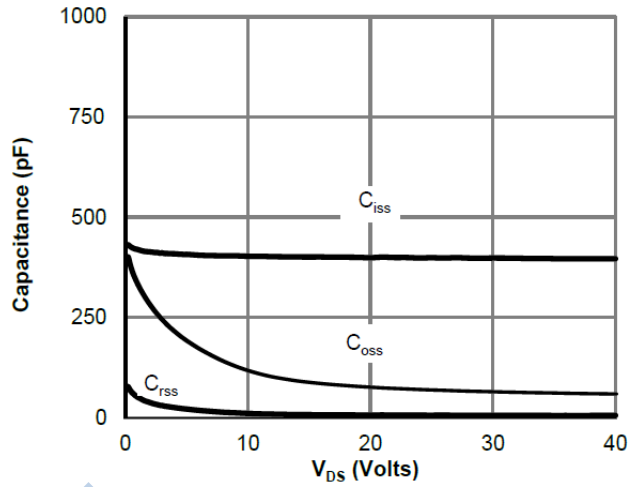
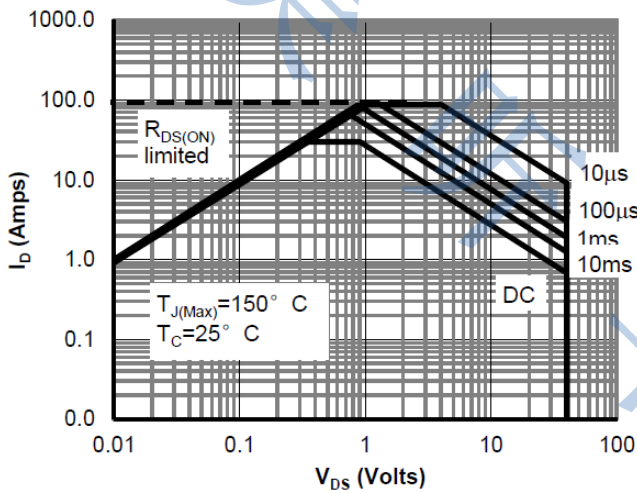
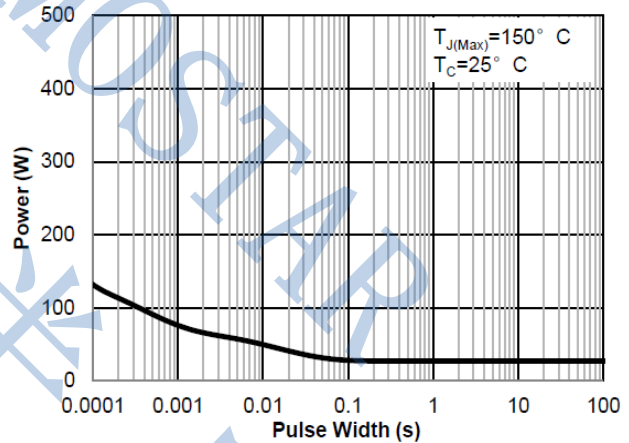
**Figure 4.  $R_{DS(on)}$  vs. Junction Temperature**

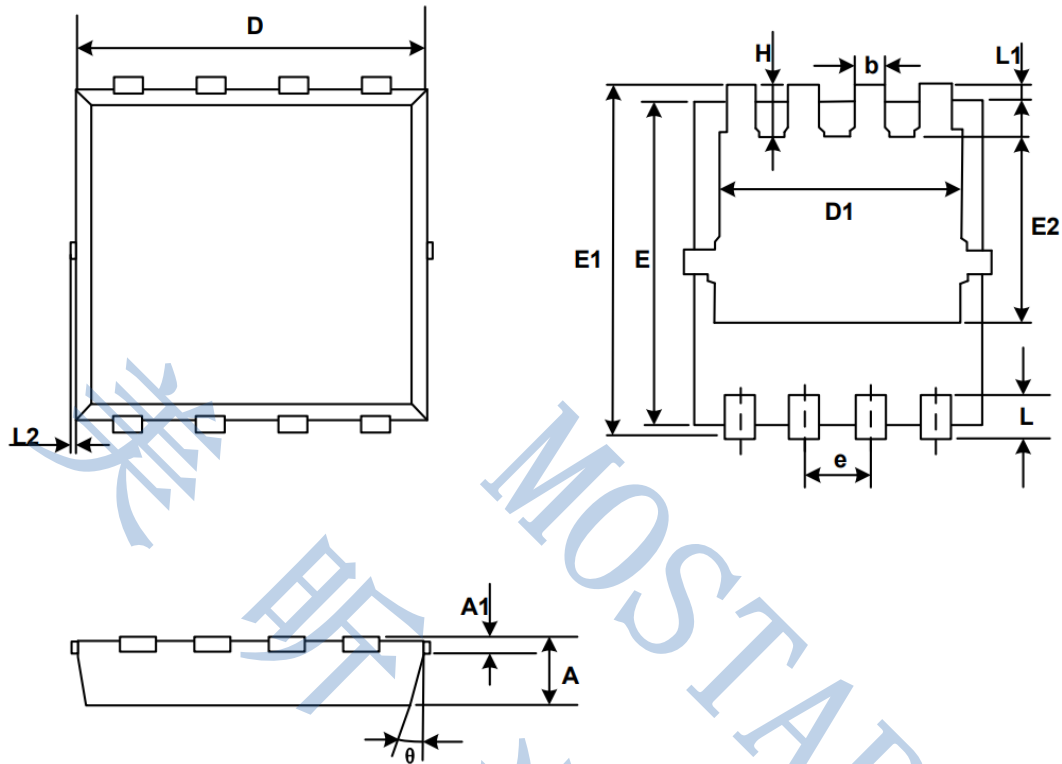


**Figure 5.  $R_{DS(on)}$  vs. Gate Voltage**



**Figure 6. Body-Diode Characteristics**


**Figure 7. Gate-Charge Characteristics**

**Figure 8. Capacitance Characteristics**

**Figure 9. Safe Operating Area**

**Figure 10. Single Pulse Power Rating  
Junction-to-Ambient**

**PDFN3030 PACKAGE INFORMATION**


Symbol	Dimensions In Millimeters(mm)	
	MIN	MAX
A	0.65	0.90
A1	0.10	0.25
D	2.90	3.25
D1	2.25	2.69
E	2.90	3.20
E1	3.00	3.60
E2	1.35	2.20
b	0.20	0.40
e	0.65BSC	
L	0.15	0.50
L1	0.13BSC	
L2	0.00	0.20
H	0.15	0.65
$\theta$	0°	14°