

65V_{DS}/±20V_{GS} N-Channel MOSFET

General Description

These N-Channel enhancement mode power field effect transistors are using SGT technology. This advanced technology has been especially tailored to minimize on-state resistance, provide superior switching performance, and withstand high energy pulse in the avalanche and commutation mode.

Features

BVDSS	65V
R_{DS(ON)}(10V)	7mΩ (TYP)
R_{DS(ON)}(4.5V)	9.5mΩ (TYP)
I_D	45A

100% UIS TESTED!

100% ΔV_{ds} TESTED!



PDFN3030

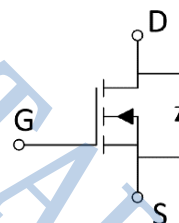
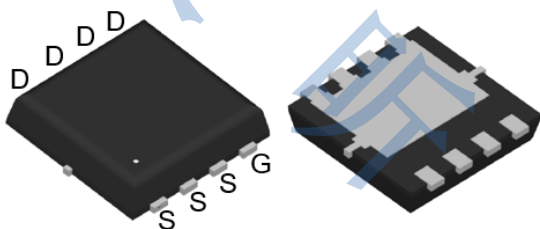

Absolute maximum ratings (T_A=25°C)

Symbol	Parameter	Value	Unit
V _{DS}	Drain-Source Voltage	65	V
V _{GS}	Gate-Source Voltage	±20	V
I _D	Continuous Drain Current (T _C =25°C)	45	A
	Continuous Drain Current (T _C =100°C)	27	A
I _{DM}	Pulsed Drain Current	180	A
I _{AS}	Avalanche Current (L=0.4mH)	17	A
E _{AS}	Single Pulsed Avalanche Energy	58	mJ
P _D	Maximum Power Dissipation (T _C =25°C)	29	W
	Maximum Power Dissipation (T _C =100°C)	11.5	W
T _J , T _{STG}	Operating, Storage Temperature Range	-55~150	°C

Thermal Characteristics

Symbol	Parameter	Typ.	Max.	Unit
R _{θJC}	Thermal Resistance, Junction-to-Case	4.3	---	°C/W
R _{θJA}	Thermal Resistance, Junction-to-Ambient	56	---	°C/W

Electrical Characteristics ($T_J=25^{\circ}\text{C}$, unless otherwise noted)

Static State Characteristics

Symbol	Parameter	Test Conditions	Min.	Typ.	Max.	Unit
B_{VDSS}	Drain-Source Breakdown Voltage	$V_{GS}=0V, I_D=250\mu A$	65	---	---	V
I_{DSS}	Zero Gate Voltage Drain Current	$V_{DS}=65V, V_{GS}=0V$	---	---	1	μA
I_{GSS}	Gate -Source Leakage Current	$V_{GS}=\pm 20V, V_{DS}=0V$	---	---	± 100	nA
$V_{GS(th)}$	Gate Threshold Voltage	$V_{DS}=V_{GS}, I_D=250\mu A$	1.3	1.7	2.2	V
$R_{DS(ON)}$	Drain-Source On-stage Resistance	$V_{GS}=10V, I_D=20A$	---	7	9	m Ω
		$V_{GS}=4.5V, I_D=10A$	---	9.5	13	

Dynamic Characteristics

Symbol	Parameter	Test Conditions	Min.	Typ.	Max.	Unit
C_{iss}	Input capacitance	$V_{DS}=30V$ $V_{GS}=0V$ $f=1MHz$	---	1215	---	pF
C_{oss}	Output capacitance		---	370	---	
C_{riss}	Reverse transfer capacitance		---	19	---	
R_g	Gate Resistance	$f=1MHz$	---	1.6	---	Ω
Q_g	Total Gate Charge	$V_{DS}=30V$	---	22	---	nC
Q_{gs}	Gate Source Charge	$V_{GS}=10V$	---	3.7	---	
Q_{gd}	Gate Drain Charge	$I_D=20A$	---	4.3	---	
$t_{d(on)}$	Turn-on delay Time	$V_{DS}=30V$ $V_{GS}=10V$ $R_G=3\Omega$ $I_D=20A$	---	7.5	---	ns
t_r	Rise time		---	8.7	---	
$t_{d(off)}$	Turn-off delay Time		---	19.5	---	
t_f	Fall time		---	6	---	
V_{SD}	Diode Forward Voltage	$V_{GS}=0V, I_{SD}=20A$	---	0.8	1.2	V
t_{rr}	Reverse Recovery Time	$I_D=20A$	---	35	---	ns
Q_{rr}	Reverse Recovery Charge	$d_i/d_t=100A/\mu s$	---	16	---	nC

Note:

- 1.Repetitive Rating : Pulsed width limited by maximum junction temperature.
- 2.The data tested by pulsed , pulse width $\leq 300\mu s$, duty cycle $\leq 2\%$.
- 3.Essentially independent of operating temperature.

Electrical Characteristics Diagrams

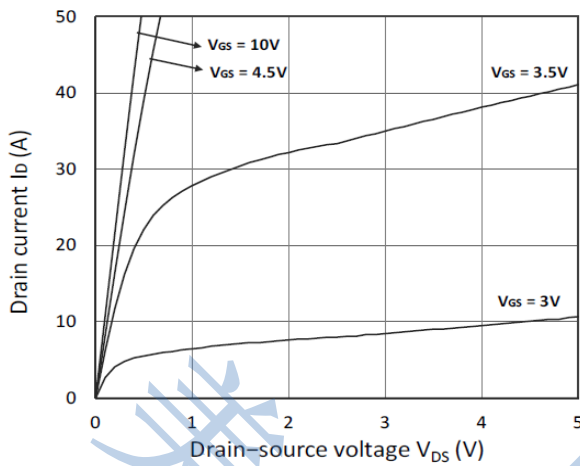
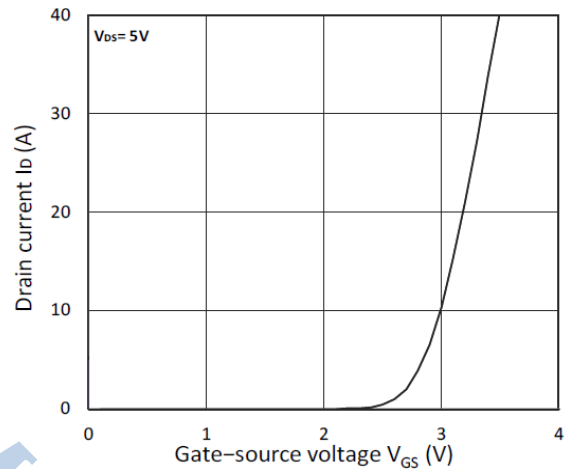
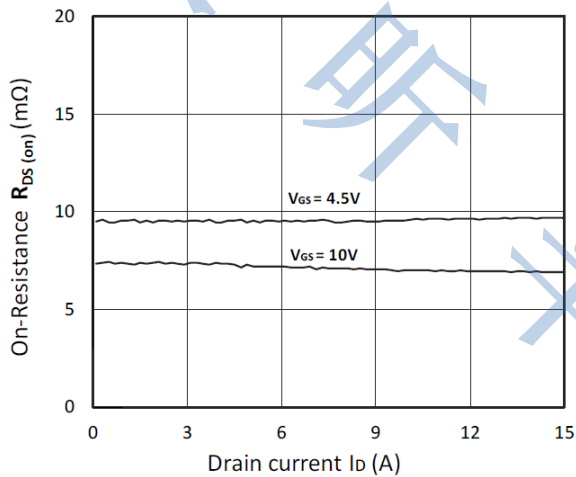
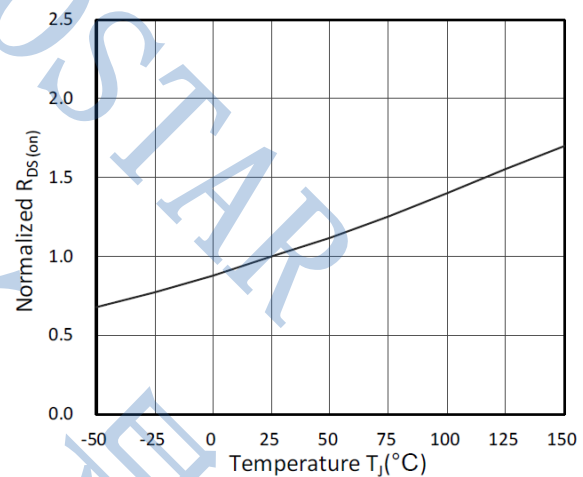
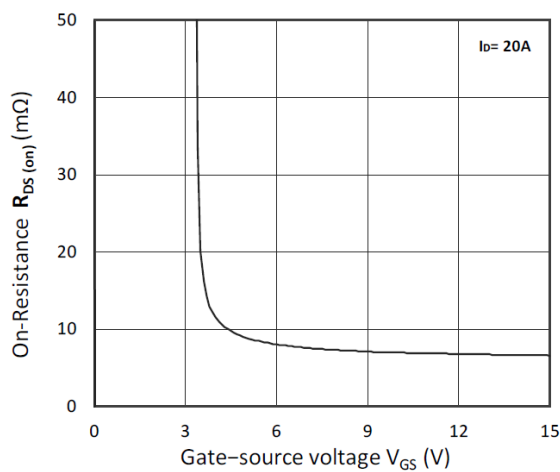
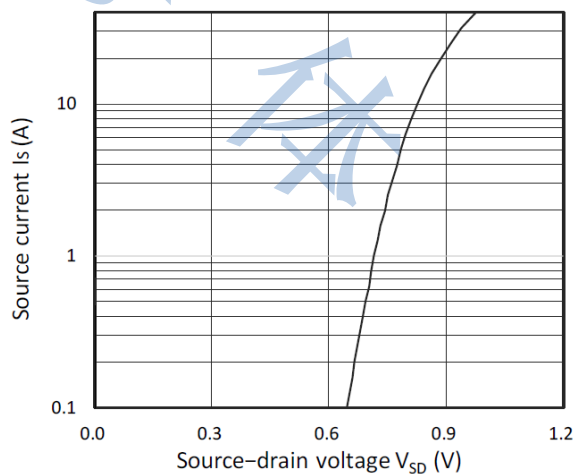
Figure 1. On-Region Characteristics

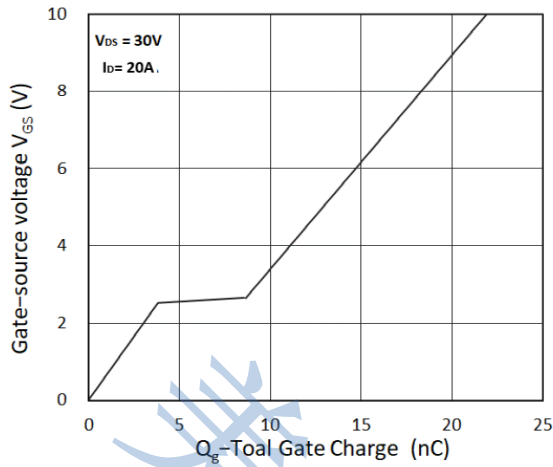
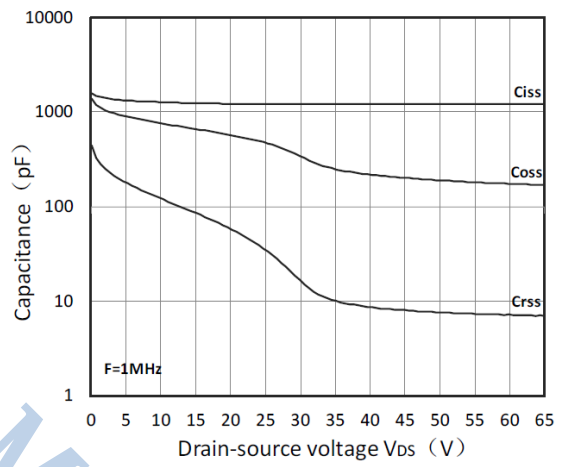
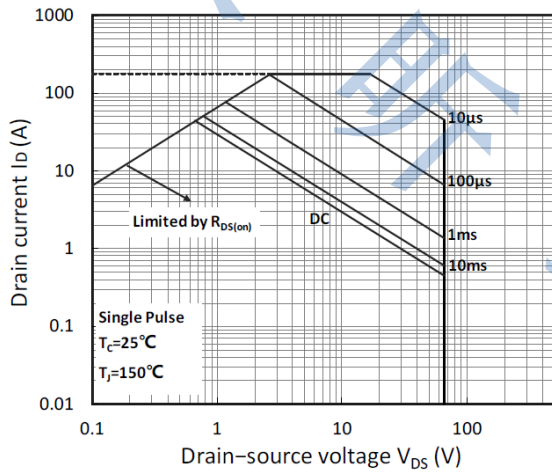
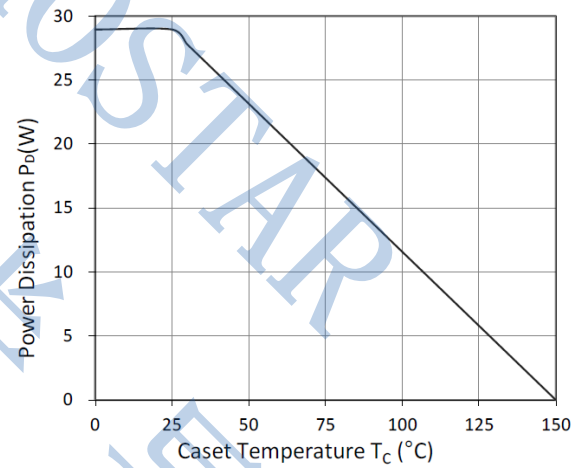
Figure 2. Transfer Characteristics

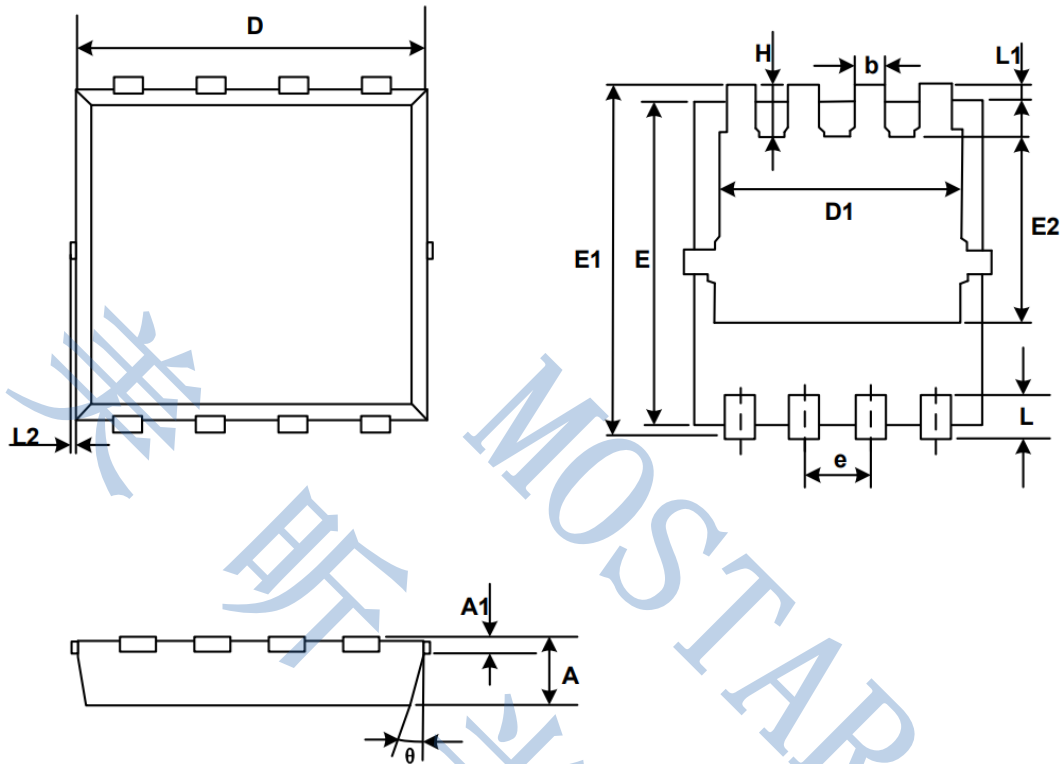
Figure 3. $R_{DS(on)}$ vs. I_D and Gate Voltage

Figure 4. $R_{DS(on)}$ vs. Junction Temperature

Figure 5. $R_{DS(on)}$ vs. Gate Voltage

Figure 6. Body-Diode Characteristics

Figure 7. Gate-Charge Characteristics

Figure 8. Capacitance Characteristics

Figure 9. Safe Operating Area

Figure 10. Power Dissipation

PDFN3030 PACKAGE INFORMATION

Symbol	Dimensions In Millimeters(mm)	
	MIN	MAX
A	0.65	0.90
A1	0.10	0.25
D	2.90	3.25
D1	2.25	2.69
E	2.90	3.20
E1	3.00	3.60
E2	1.35	2.20
b	0.20	0.40
e	0.65BSC	
L	0.15	0.50
L1	0.13BSC	
L2	0.00	0.20
H	0.15	0.65
θ	0°	14°