

40V_{DS}/±20V_{GS} N-Channel MOSFET

General Description

These N-Channel enhancement mode power field effect transistors are using SGT technology. This advanced technology has been especially tailored to minimize on-state resistance, provide superior switching performance, and withstand high energy pulse in the avalanche and commutation mode.

Features

BVDSS	40V
R_{DS(ON)}(10V)	7.0mΩ (TYP)
R_{DS(ON)}(4.5V)	9.5mΩ (TYP)
I_D	45A

100% UIS TESTED!

100% ΔV_{ds} TESTED!



PDFN5060

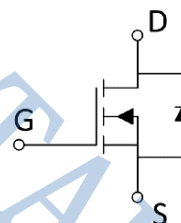
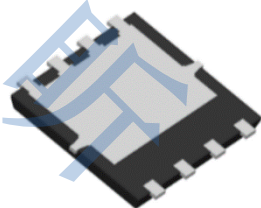
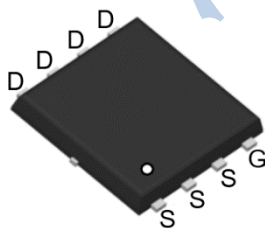

Absolute maximum ratings (T_A=25°C)

Symbol	Parameter	Value	Unit
V _{DS}	Drain-Source Voltage	40	V
V _{GS}	Gate-Source Voltage	±20	V
I _D	Continuous Drain Current (T _C =25°C)	45	A
	Continuous Drain Current (T _C =100°C)	29	A
I _{DM}	Pulsed Drain Current	120	A
I _{AS}	Avalanche Current (L=0.1mH)	30	A
E _{AS}	Single Pulsed Avalanche Energy	45	mJ
P _D	Maximum Power Dissipation (T _C =25°C)	37	W
	Maximum Power Dissipation (T _C =100°C)	15	W
T _J , T _{STG}	Operating, Storage Temperature Range	-55~150	°C

Thermal Characteristics

Symbol	Parameter	Typ.	Max.	Unit
R _{θJC}	Thermal Resistance, Junction-to-Case	3.3	---	°C/W
R _{θJA}	Thermal Resistance, Junction-to-Ambient	48	---	°C/W

Electrical Characteristics ($T_J=25^{\circ}\text{C}$, unless otherwise noted)

Static State Characteristics

Symbol	Parameter	Test Conditions	Min.	Typ.	Max.	Unit
B_{VDSS}	Drain-Source Breakdown Voltage	$V_{GS}=0V, I_D=250\mu A$	40	---	---	V
I_{DSS}	Zero Gate Voltage Drain Current	$V_{DS}=40V, V_{GS}=0V$	---	---	1	μA
I_{GSS}	Gate -Source Leakage Current	$V_{GS}=\pm 20V, V_{DS}=0V$	---	---	± 100	nA
$V_{GS(th)}$	Gate Threshold Voltage	$V_{DS}=V_{GS}, I_D=250\mu A$	1.0	1.5	2.0	V
$R_{DS(ON)}$	Drain-Source On-stage Resistance	$V_{GS}=10V, I_D=20A$	---	7.0	9.0	m Ω
		$V_{GS}=4.5V, I_D=20A$	---	9.5	12.0	

Dynamic Characteristics

Symbol	Parameter	Test Conditions	Min.	Typ.	Max.	Unit
C_{iss}	Input capacitance	$V_{DS}=20V$ $V_{GS}=0V$ $f=1MHz$	---	685	---	pF
C_{oss}	Output capacitance		---	121	---	
C_{rss}	Reverse transfer capacitance		---	10.5	---	
R_g	Gate Resistance	$f=1MHz$	---	3	---	Ω
Q_g	Total Gate Charge	$V_{DS}=20V$ $V_{GS}=10V$ $I_D=20A$	---	9.5	---	nC
Q_{gs}	Gate Source Charge		---	2.1	---	
Q_{gd}	Gate Drain Charge		---	0.9	---	
$t_{d(on)}$	Turn-on delay Time	$V_{DS}=20V$ $V_{GS}=10V$ $R_G=3\Omega$ $I_D=20A$	---	8.2	---	ns
t_r	Rise time		---	2.5	---	
$t_{d(off)}$	Turn-off delay Time		---	26	---	
t_f	Fall time		---	3.9	---	
V_{SD}	Diode Forward Voltage	$V_{GS}=0V, I_{SD}=10A$	---	0.7	1.2	V
t_{rr}	Reverse Recovery Time	$I_D=20A$ $d_i/d_t=100A/\mu s$	---	13	---	ns
Q_{rr}	Reverse Recovery Charge		---	24	---	nC

Note:

- 1.Repetitive Rating : Pulsed width limited by maximum junction temperature.
- 2.The data tested by pulsed , pulse width $\leq 300\mu s$, duty cycle $\leq 2\%$.
- 3.Essentially independent of operating temperature.

Electrical Characteristics Diagrams

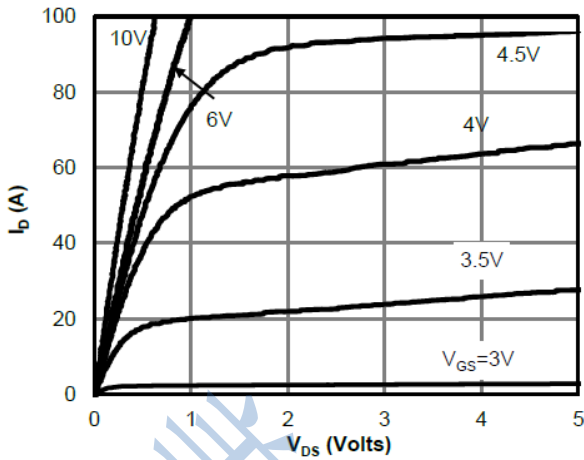

Figure 1. On-Region Characteristics

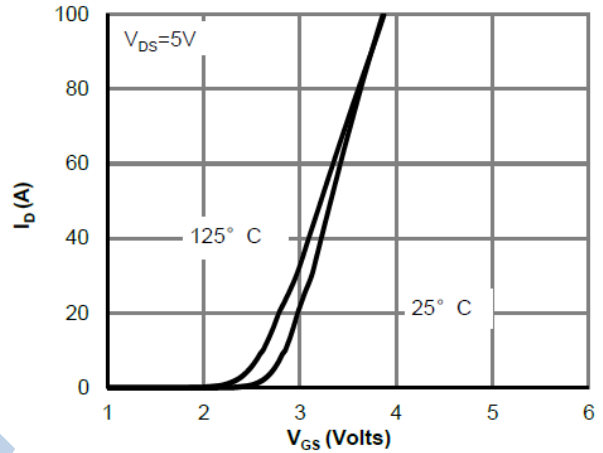

Figure 2. Transfer Characteristics

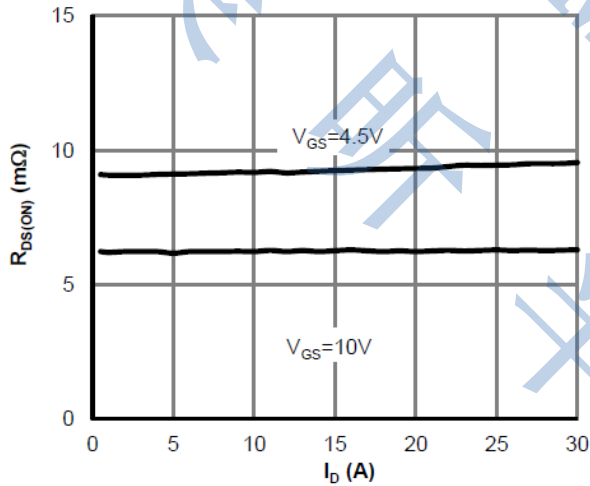

Figure 3. $R_{DS(on)}$ vs. I_D and Gate Voltage

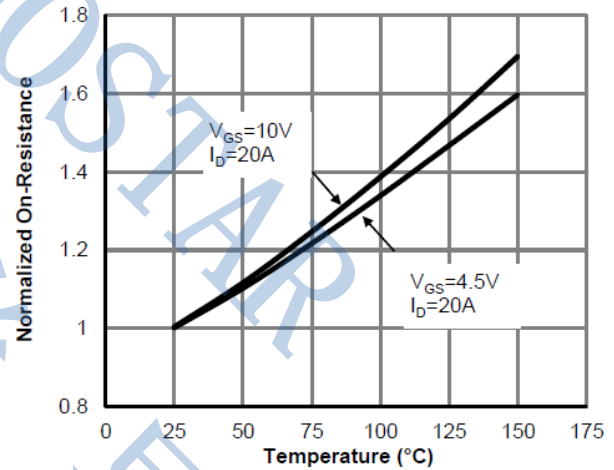

Figure 4. $R_{DS(on)}$ vs. Junction Temperature

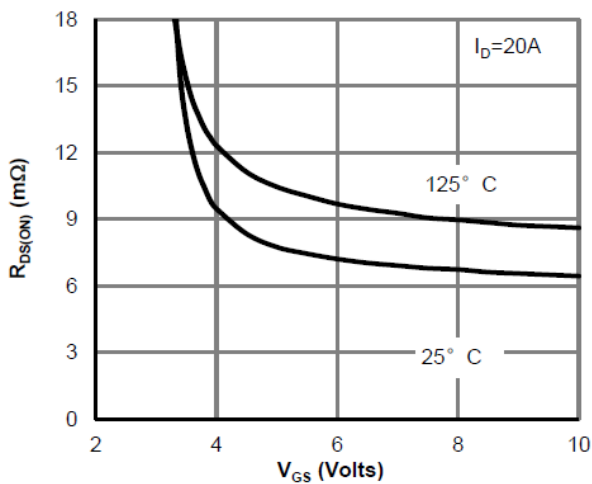

Figure 5. $R_{DS(on)}$ vs. Gate Voltage

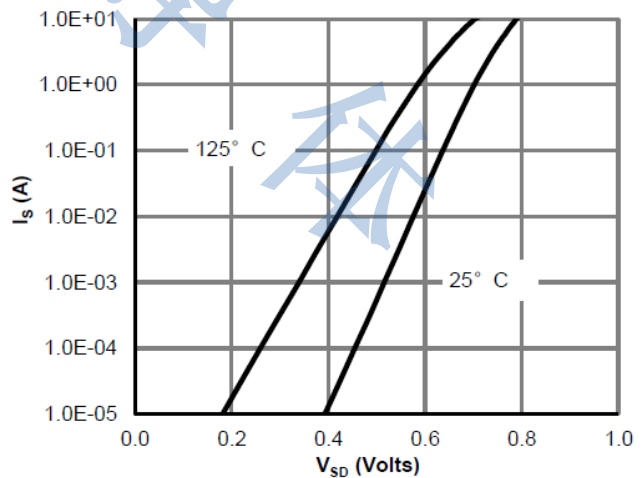
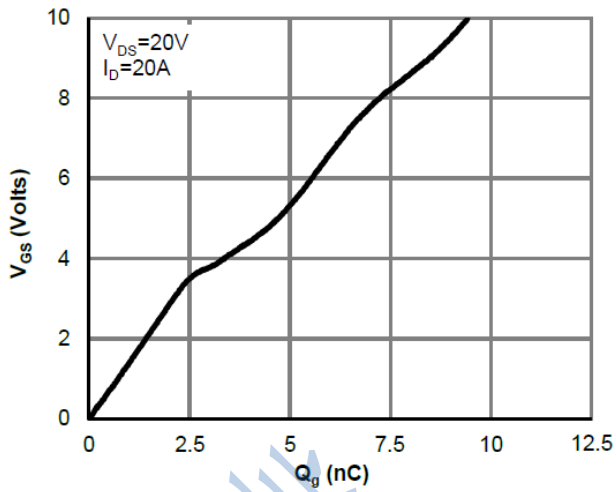
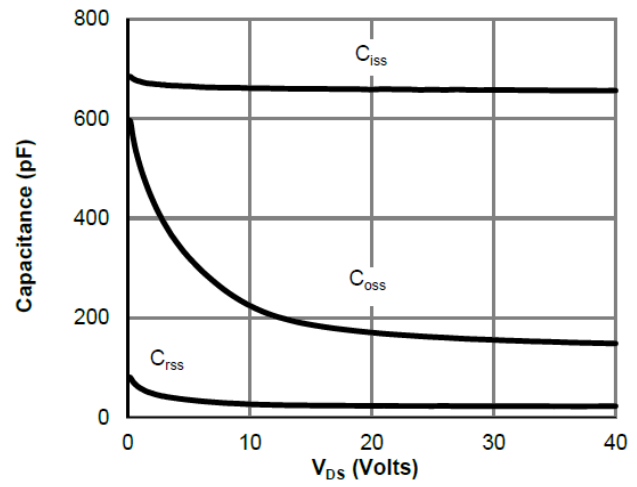
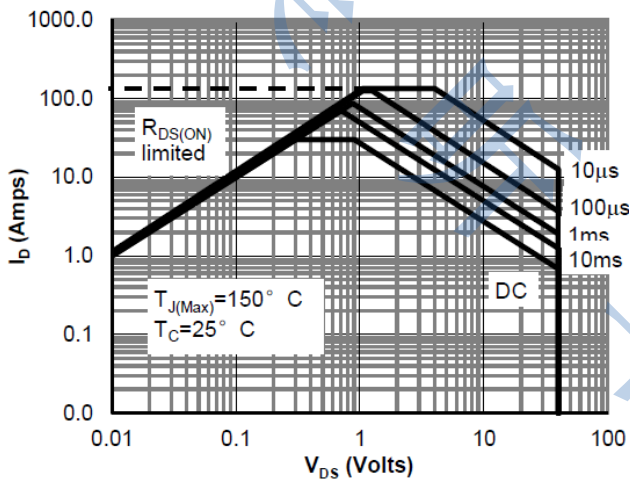
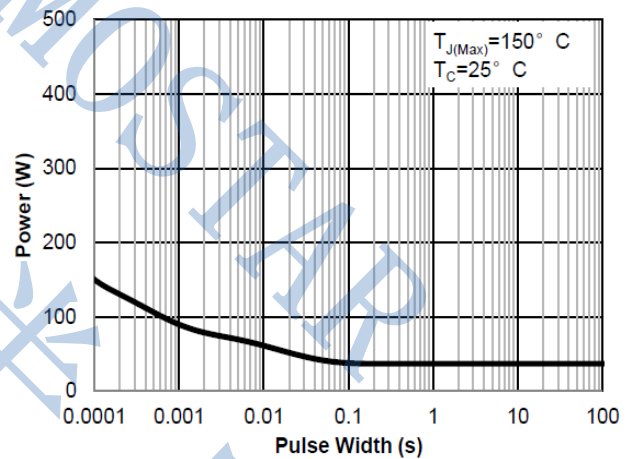
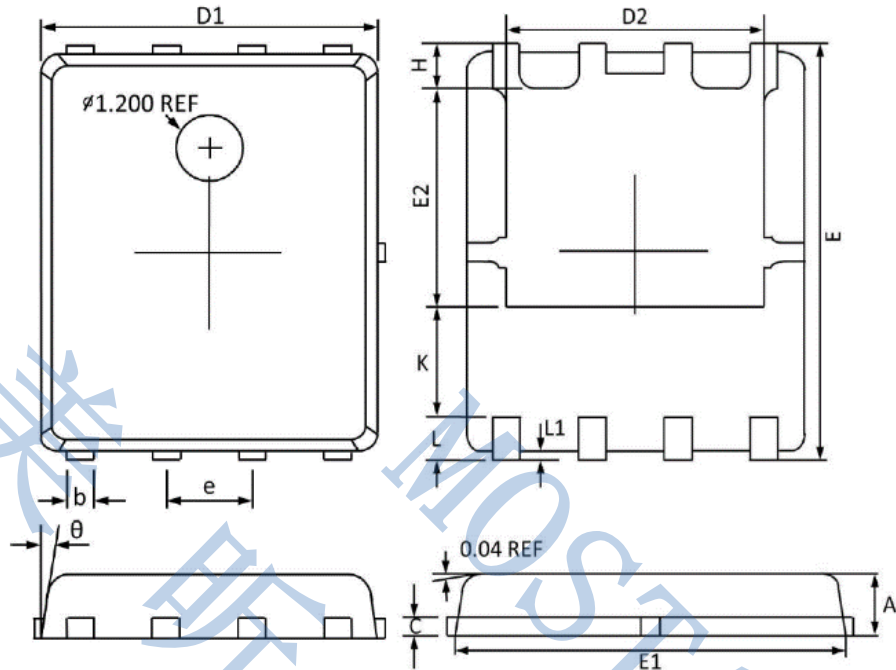

Figure 6. Body-Diode Characteristics

Figure 7. Gate-Charge Characteristics

Figure 8. Capacitance Characteristics

Figure 9. Safe Operating Area

**Figure 10. Single Pulse Power Rating
Junction-to-Ambient**

PDFN5060 PACKAGE INFORMATION

Symbol	Dimensions In Millimeters(mm)	
	MIN	MAX
A	0.800	1.100
b	0.330	0.510
C	0.200	0.300
D1	4.800	5.100
D2	3.610	4.100
E	5.900	6.200
E1	5.700	5.900
E2	3.350	3.780
e	1.27BSC	
H	0.410	0.700
K	1.100	1.500
L	0.510	0.710
L1	0.060	0.200
θ	0°	12°